

**NOTES:**  
 1) PRODUCT MUST BE INSTALLED IN COMPLIANCE WITH ALL NATIONAL AND LOCAL ELECTRICAL REGULATIONS  
 2) PLEASE REFER TO UPS PRODUCT MANUALS FOR ADDITIONAL INFORMATION  
 3) ALL DIMENSIONS IN MM UNLESS OTHERWISE SPECIFIED  
 4) 4 - CORE SHIELDED SIGNAL CABLE MUST BE RUN FROM EMBS TO EACH UPS UNIT  
 5) ALL DASHED LINES EXTERNAL TO BYPASS PANEL

PRODUCT REF:	RB1-EMBS-63A-31P-ISO-422
DOCUMENT NUMBER:	RBECAD01076
PAGE DESCRIPTION:	MAIN SWITCH'S
PROJECT NO:	SUBMITTAL DRAWING
PAGE TEMPLATE REF:	RBQS00075REV2
PRODUCT WEIGHT:	20KG

REV NO:	1
CREATION DATE:	29/04/2016
REV DATE:	03/01/2023
DRAWN BY:	L RICHARDSON
CHECKED BY:	D WARD
SHEET NUMBER:	1 OF 5

EXAMPLE UPS UNIT CONNECTION DIAGRAM FOR ILLUSTRATION ONLY  
 CHECK WITH UPS UNIT SUPPLIER FOR EXACT CONNECTION  
 CONFIGURATION FOR THE AC, DC AND AUXILLARY CONNECTIONS

PHASE EXAMPLE UPS UNIT1

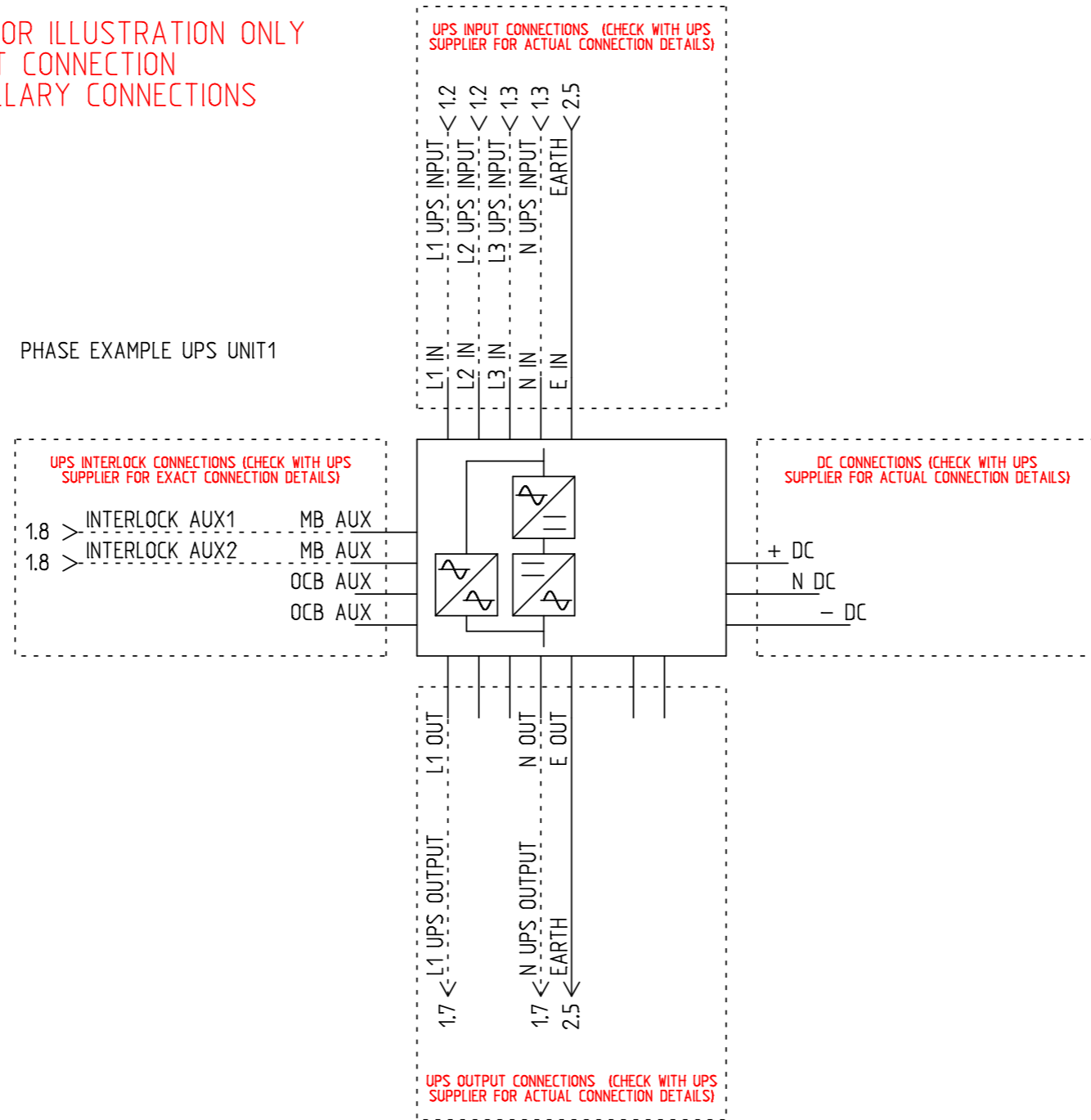

**NOTES:**

- 1) PRODUCT MUST BE INSTALLED IN COMPLIANCE WITH ALL NATIONAL AND LOCAL ELECTRICAL REGULATIONS
- 2) PLEASE REFER TO UPS PRODUCT MANUALS FOR ADDITIONAL INFORMATION
- 3) ALL DIMENSIONS IN MM UNLESS OTHERWISE SPECIFIED
- 4) 4 - CORE SHIELDED SIGNAL CABLE MUST BE RUN FROM EMBS TO EACH UPS UNIT
- 5) ALL DASHED LINES EXTERNAL TO BYPASS PANEL

PRODUCT REF:	RB1-EMBS-63A-31P-ISO-422	REV NO:	1
DOCUMENT NUMBER:	RBECAD01076	CREATION DATE:	11/05/2016
PAGE DESCRIPTION:	UPS UNIT	REV DATE:	03/01/2023
PROJECT NO:	SUBMITTAL DRAWING	DRAWN BY:	L RICHARDSON
PAGE TEMPLATE REF:	RBQS00078REV2	CHECKED BY:	D WARD
PRODUCT WEIGHT:	20KG	SHEET NUMBER:	2 OF 5

DO NOT USE THIS PROCEDURE IF THE MAINS IS NOT AVAILABLE. IF IN ANY DOUBT CONTACT YOUR UPS SERVICE PROVIDER.

### STEP A (NORMAL POSITION)

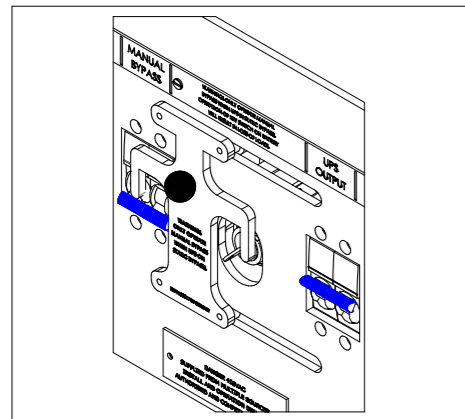

MANUAL BYPASS:  
-IN THE OFF POSITION

INTERLOCK KEY :  
-INSERTED + TURNED CLOCKWISE

UPS OUTPUT:  
-IN THE ON POSITION

UPS UNIT:  
-ONLINE - LOAD ON UPS

### STEP B

REFER TO UPS USER MANUAL TO SWITCH THE UPS UNIT (OR UNITS) TO STATIC BYPASS

ONCE UPS UNIT (OR UNITS) ARE IN STATIC BYPASS CONTINUE THE SWITCHING SEQUENCE

MANUAL BYPASS:  
-IN THE OFF POSITION

INTERLOCK KEY :  
-INSERTED + TURNED CLOCKWISE

UPS OUTPUT:  
-IN THE ON POSITION

UPS UNIT:  
-STATIC BYPASS - LOAD ON MAINS

### STEP C

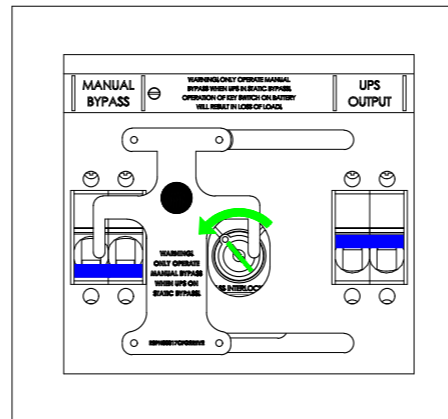

MANUAL BYPASS:  
-IN THE OFF POSITION

INTERLOCK KEY :  
-INSERTED + TURNED ANTI-CLOCKWISE

UPS OUTPUT:  
-IN THE ON POSITION

UPS UNIT:  
-STATIC BYPASS - LOAD ON MAINS

### STEP D

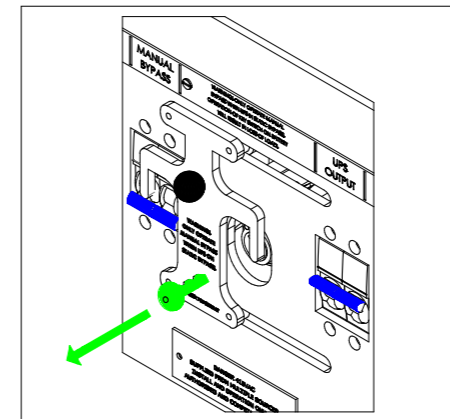

MANUAL BYPASS:  
-IN THE OFF POSITION

INTERLOCK KEY :  
-REMOVED

UPS OUTPUT:  
-IN THE ON POSITION

UPS UNIT:  
-STATIC BYPASS - LOAD ON MAINS

### STEP E

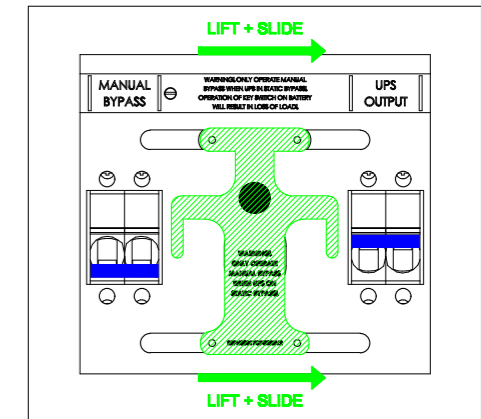

MANUAL BYPASS:  
-IN THE OFF POSITION

INTERLOCK KEY :  
-REMOVED

UPS OUTPUT:  
-IN THE ON POSITION

UPS UNIT:  
-STATIC BYPASS - LOAD ON MAINS

### STEP F

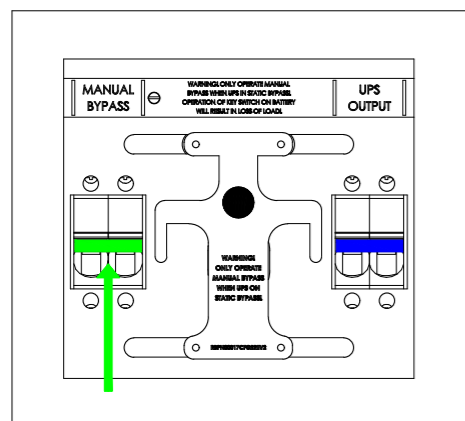

MANUAL BYPASS:  
-IN THE ON POSITION

INTERLOCK KEY :  
-REMOVED

UPS OUTPUT:  
-IN THE ON POSITION

UPS UNIT:  
-STATIC BYPASS - LOAD ON MAINS

### STEP G

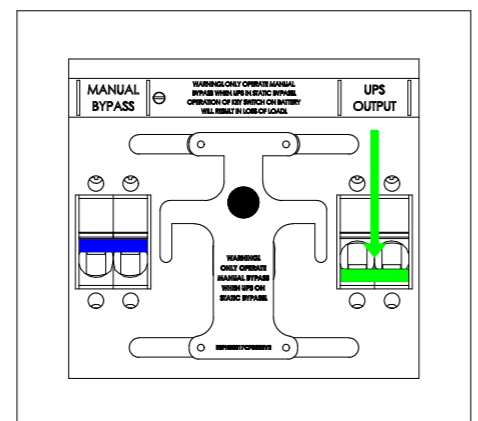

MANUAL BYPASS:  
-IN THE ON POSITION

INTERLOCK KEY :  
-REMOVED

UPS OUTPUT:  
-IN THE OFF POSITION

UPS UNIT:  
-STATIC BYPASS - LOAD ON MAINS

### STEP H

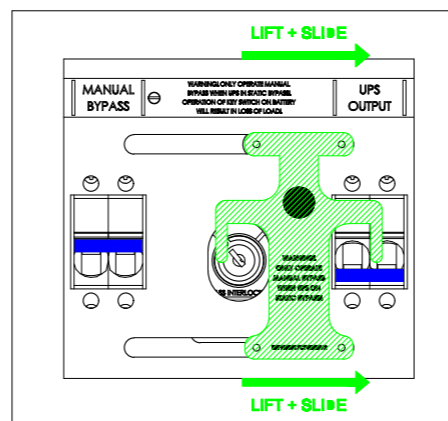

MANUAL BYPASS:  
-IN THE ON POSITION

INTERLOCK KEY :  
-REMOVED

UPS OUTPUT:  
-IN THE OFF POSITION

UPS UNIT:  
-STATIC BYPASS - LOAD ON MAINS

### STEP I

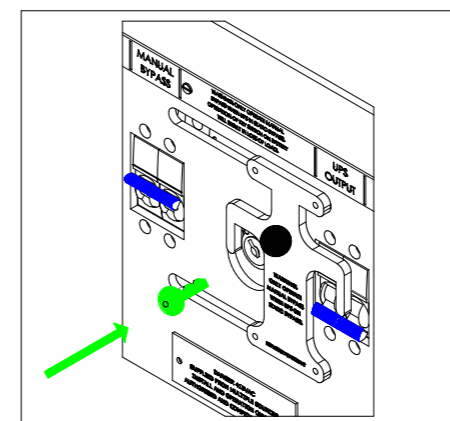

MANUAL BYPASS:  
-IN THE ON POSITION

INTERLOCK KEY :  
-INSERTED + TURNED ANTI-CLOCKWISE

UPS OUTPUT:  
-IN THE OFF POSITION

UPS UNIT:  
-STATIC BYPASS - LOAD ON MAINS

### STEP J

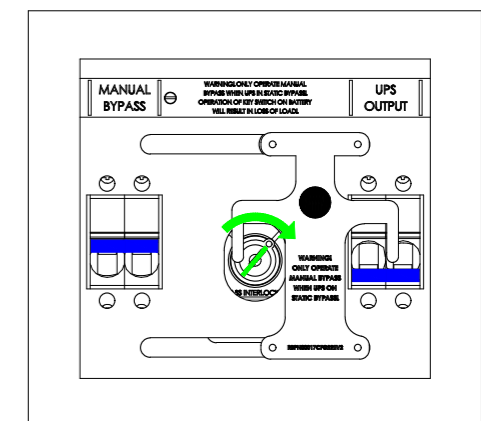

MANUAL BYPASS:  
-IN THE ON POSITION

INTERLOCK KEY :  
-INSERTED + TURNED CLOCKWISE

UPS OUTPUT:  
-IN THE OFF POSITION

UPS UNIT:  
-STATIC BYPASS - LOAD ON MAINS

#### NOTES:

- 1) PRODUCT MUST BE INSTALLED IN COMPLIANCE WITH ALL NATIONAL AND LOCAL ELECTRICAL REGULATIONS
- 2) PLEASE REFER TO UPS PRODUCT MANUALS FOR ADDITIONAL INFORMATION
- 3) ALL DIMENSIONS IN MM UNLESS OTHERWISE SPECIFIED
- 4) 4 - CORE SHIELDED SIGNAL CABLE MUST BE RUN FROM EMBS TO EACH UPS UNIT
- 5) ALL DASHED LINES EXTERNAL TO BYPASS PANEL

PRODUCT REF:	RB1-EMBS-63A-31P-ISO-422
DOCUMENT NUMBER:	RBECAD01076
PAGE DESCRIPTION:	INTERLOCK OPERATION PAGE 1
PROJECT NO:	SUBMITTAL DRAWING
PAGE TEMPLATE REF:	RBQS00078REV2
PRODUCT WEIGHT:	20KG

REV NO:	1
CREATION DATE:	29/04/2016
REV DATE:	03/01/2023
DRAWN BY:	L RICHARDSON
CHECKED BY:	D WARD
SHEET NUMBER:	3 OF 5

DO NOT USE THIS PROCEDURE IF THE MAINS IS NOT AVAILABLE. IF IN ANY DOUBT CONTACT YOUR UPS SERVICE PROVIDER.

### STEP K (ON BYPASS POSITION)

THIS PROCEDURE ASSUMES:

ALL SWITCH'S ON THE EMBS AND ON THE UPS UNIT SHOULD STILL BE AS PER STEP J ON THE PREVIOUS PAGE PRIOR TO PROCEEDING

THE UPS UNIT SHOULD BE IN STATIC BYPASS AND SHOULD BE READY TO ACCEPT THE SYSTEM LOAD

IF IN ANY DOUBT CONTACT YOUR UPS SYSTEM SERVICE PROVIDER BEFORE PROCEEDING

MANUAL BYPASS:  
-IN THE ON POSITION

INTERLOCK KEY :  
-INSERTED + TURNED CLOCKWISE

UPS OUTPUT:  
-IN THE OFF POSITION

UPS UNIT:  
-STATIC BYPASS - LOAD ON MAINS

### STEP L

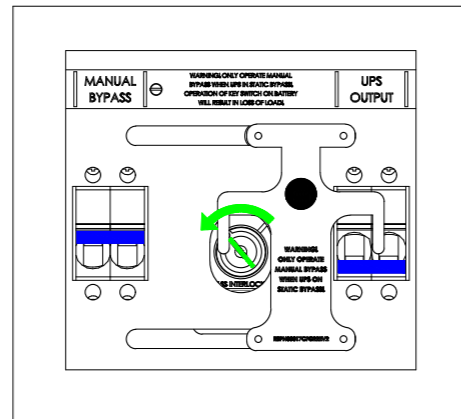

MANUAL BYPASS:  
-IN THE ON POSITION

INTERLOCK KEY :  
-INSERTED + TURNED ANTI-CLOCKWISE

UPS OUTPUT:  
-IN THE OFF POSITION

UPS UNIT:  
-STATIC BYPASS - LOAD ON MAINS

### STEP M

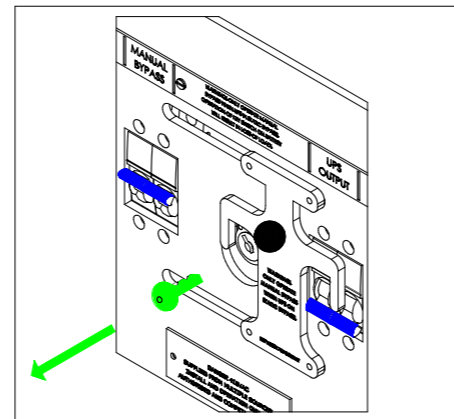

MANUAL BYPASS:  
-IN THE ON POSITION

INTERLOCK KEY :  
-REMOVED

UPS OUTPUT:  
-IN THE OFF POSITION

UPS UNIT:  
-STATIC BYPASS - LOAD ON MAINS

### STEP N

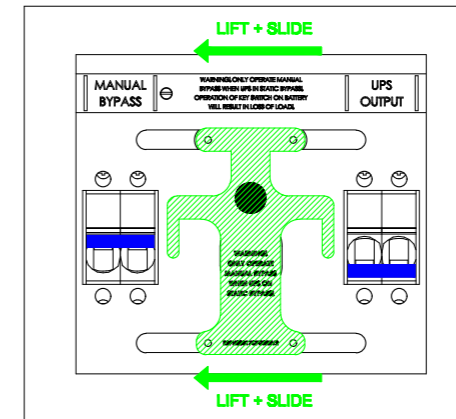

MANUAL BYPASS:  
-IN THE ON POSITION

INTERLOCK KEY :  
-REMOVED

UPS OUTPUT:  
-IN THE OFF POSITION

UPS UNIT:  
-STATIC BYPASS - LOAD ON MAINS

### STEP O

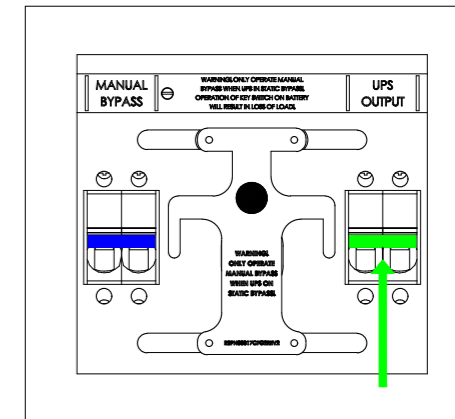

MANUAL BYPASS:  
-IN THE ON POSITION

INTERLOCK KEY :  
-REMOVED

UPS OUTPUT:  
-IN THE ON POSITION

UPS UNIT:  
-STATIC BYPASS - LOAD ON MAINS

### STEP P

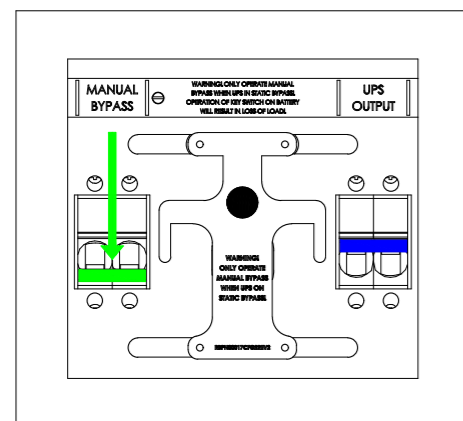

MANUAL BYPASS:  
-IN THE OFF POSITION

INTERLOCK KEY :  
-REMOVED

UPS OUTPUT:  
-IN THE ON POSITION

UPS UNIT:  
-STATIC BYPASS - LOAD ON MAINS

### STEP Q

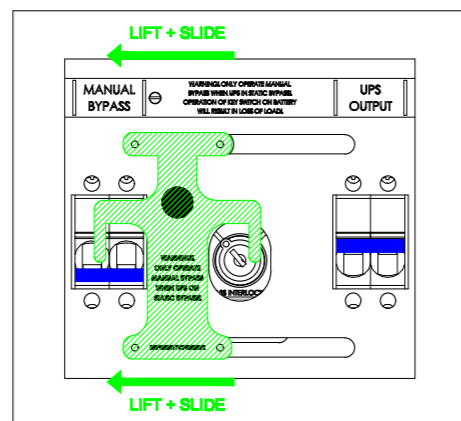

MANUAL BYPASS:  
-IN THE OFF POSITION

INTERLOCK KEY :  
-REMOVED

UPS OUTPUT:  
-IN THE ON POSITION

UPS UNIT:  
-STATIC BYPASS - LOAD ON MAINS

### STEP R

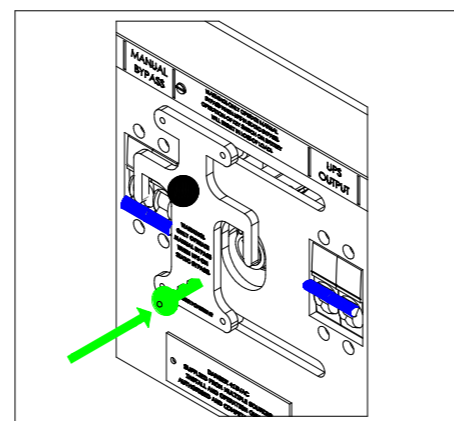

MANUAL BYPASS:  
-IN THE OFF POSITION

INTERLOCK KEY :  
-INSERTED + TURNED ANTI-CLOCKWISE

UPS OUTPUT:  
-IN THE ON POSITION

UPS UNIT:  
-STATIC BYPASS - LOAD ON MAINS

### STEP S

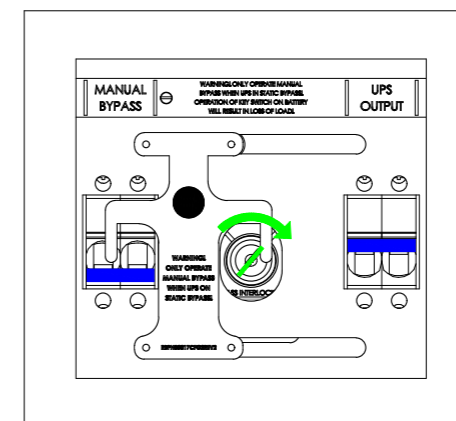

MANUAL BYPASS:  
-IN THE OFF POSITION

INTERLOCK KEY :  
-INSERTED + TURNED CLOCKWISE

UPS OUTPUT:  
-IN THE ON POSITION

UPS UNIT:  
-STATIC BYPASS - LOAD ON MAINS

### STEP T

REFER TO UPS USER MANUAL TO SWITCH THE UPS UNIT (OR UNITS) TO ONLINE MODE

ONCE UPS UNIT (OR UNITS) ARE ONLINE THE SEQUENCE IS COMPLETE AND THE LOAD IS NOW BACKED UP BY UPS

IF IN ANY DOUBT CONTACT YOUR UPS SERVICE PROVIDER

MANUAL BYPASS:  
-IN THE OFF POSITION

INTERLOCK KEY :  
-INSERTED + TURNED CLOCKWISE

UPS OUTPUT:  
-IN THE ON POSITION

UPS UNIT:  
-ONLINE - LOAD ON UPS

#### NOTES:

- 1) PRODUCT MUST BE INSTALLED IN COMPLIANCE WITH ALL NATIONAL AND LOCAL ELECTRICAL REGULATIONS
- 2) PLEASE REFER TO UPS PRODUCT MANUALS FOR ADDITIONAL INFORMATION
- 3) ALL DIMENSIONS IN MM UNLESS OTHERWISE SPECIFIED
- 4) 4 - CORE SHIELDED SIGNAL CABLE MUST BE RUN FROM EMBS TO EACH UPS UNIT
- 5) ALL DASHED LINES EXTERNAL TO BYPASS PANEL

PRODUCT REF:

RB1-EMBS-63A-31P-ISO-422

DOCUMENT NUMBER:

RBECAD01076

PAGE DESCRIPTION:

INTERLOCK OPERATION PAGE 2

PROJECT NO:

SUBMITTAL DRAWING

PAGE TEMPLATE REF:

RBQS00078REV2

PRODUCT WEIGHT:

20KG

REV NO:

1

CREATION DATE:

29/04/2016

REV DATE:

03/01/2023

DRAWN BY:

L RICHARDSON

CHECKED BY:

D WARD

SHEET NUMBER:

4 OF 5

MECHANICAL LAYOUT

LEFT VIEW

FRONT/REAR VIEW

RIGHT VIEW

ISOMETRIC VIEW

TOP VIEW

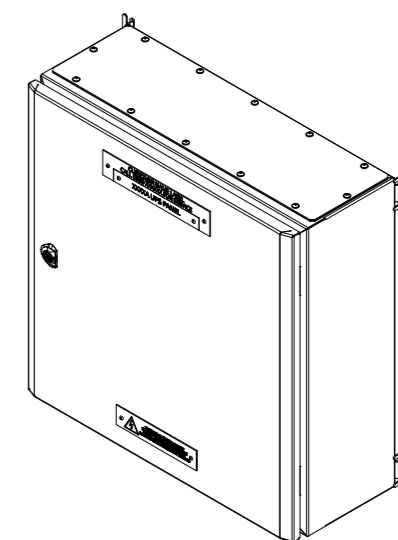
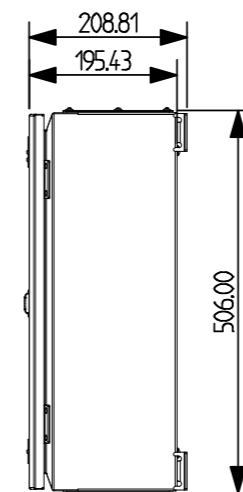
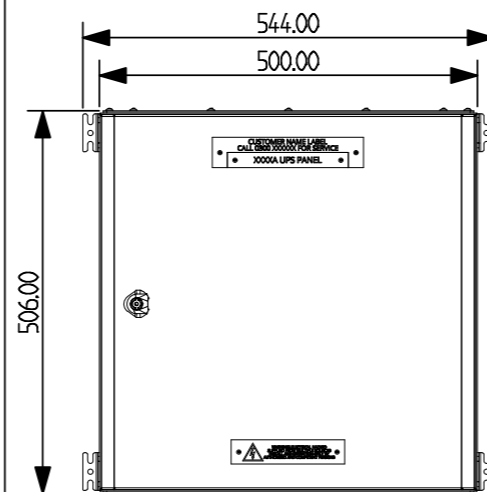
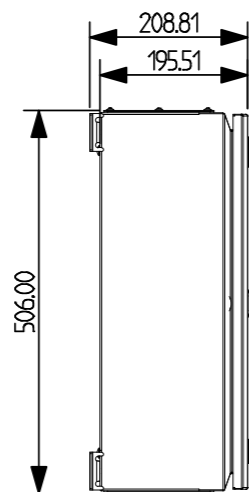
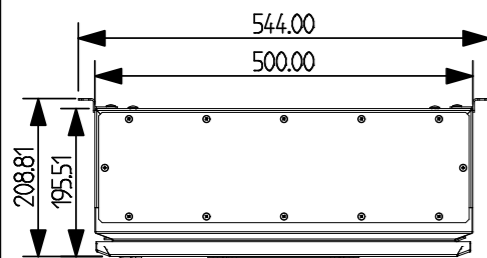

BOTTOM VIEW

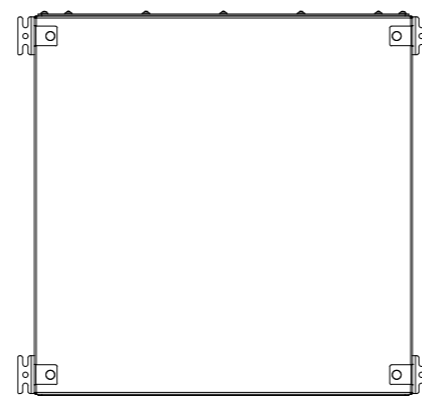
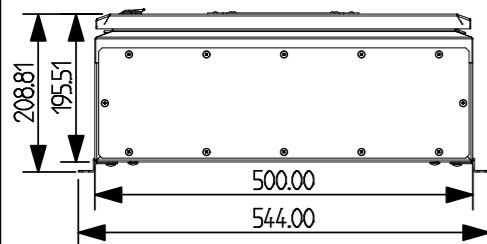

NOTES ON MECHANICAL LAYOUT:

1. ENCLOSURE CAN BE INSTALLED WITHOUT MOUNTING FEET IF PREFERRED
2. MOUNTING FEET SUPPLIED LOOSE FOR INSTALLER TO FIT
3. DOOR CAN BE HUNG ON OPPOSITE SIDE ON REQUEST

NOTES:

- 1) PRODUCT MUST BE INSTALLED IN COMPLIANCE WITH ALL NATIONAL AND LOCAL ELECTRICAL REGULATIONS
- 2) PLEASE REFER TO UPS PRODUCT MANUALS FOR ADDITIONAL INFORMATION
- 3) ALL DIMENSIONS IN MM UNLESS OTHERWISE SPECIFIED
- 4) 4 - CORE SHIELDED SIGNAL CABLE MUST BE RUN FROM EMBS TO EACH UPS UNIT
- 5) ALL DASHED LINES EXTERNAL TO BYPASS PANEL

PRODUCT REF:

RB1-EMBS-63A-31P-ISO-422

DOCUMENT NUMBER:

RBECAD01076

PAGE DESCRIPTION:

MECHANICAL LAYOUT

PROJECT NO:

SUBMITTAL DRAWING

PAGE TEMPLATE REF:

RBQS00078REV2

PRODUCT WEIGHT:

20KG

REV NO:

1

CREATION DATE:

29/04/2016

REV DATE:

03/01/2023

DRAWN BY:

L RICHARDSON

CHECKED BY:

D WARD

SHEET NUMBER:

5 OF 5