

**NOTES:**  
 1) PRODUCT MUST BE INSTALLED IN COMPLIANCE WITH ALL NATIONAL AND LOCAL ELECTRICAL REGULATIONS  
 2) PLEASE REFER TO UPS PRODUCT MANUALS FOR ADDITIONAL INFORMATION  
 3) ALL DIMENSIONS IN MM UNLESS OTHERWISE SPECIFIED  
 4) 4 - CORE SHIELDED SIGNAL CABLE MUST BE RUN FROM EMBS TO EACH UPS UNIT  
 5) ALL DASHED LINES EXTERNAL TO BYPASS PANEL

PRODUCT REF:	RB1-EMBS-400A-31P-ISO-422	REV NO:	1
DOCUMENT NUMBER:	RBECAD00542	CREATION DATE:	29/04/2016
PAGE DESCRIPTION:	MAIN SWITCH'S	REV DATE:	24/06/2019
PROJECT NO:	SUBMITTAL DRAWING	DRAWN BY:	R BARNES
PAGE TEMPLATE REF:	RBQS00075REV2	CHECKED BY:	L RICHARDSON
PRODUCT WEIGHT:	65KG	SHEET NUMBER:	1 OF 4

EXAMPLE UPS UNIT CONNECTION DIAGRAM FOR ILLUSTRATION ONLY  
 CHECK WITH UPS UNIT SUPPLIER FOR EXACT CONNECTION  
 CONFIGURATION FOR THE AC, DC AND AUXILLARY CONNECTIONS

3 PHASE EXAMPLE UPS UNIT1

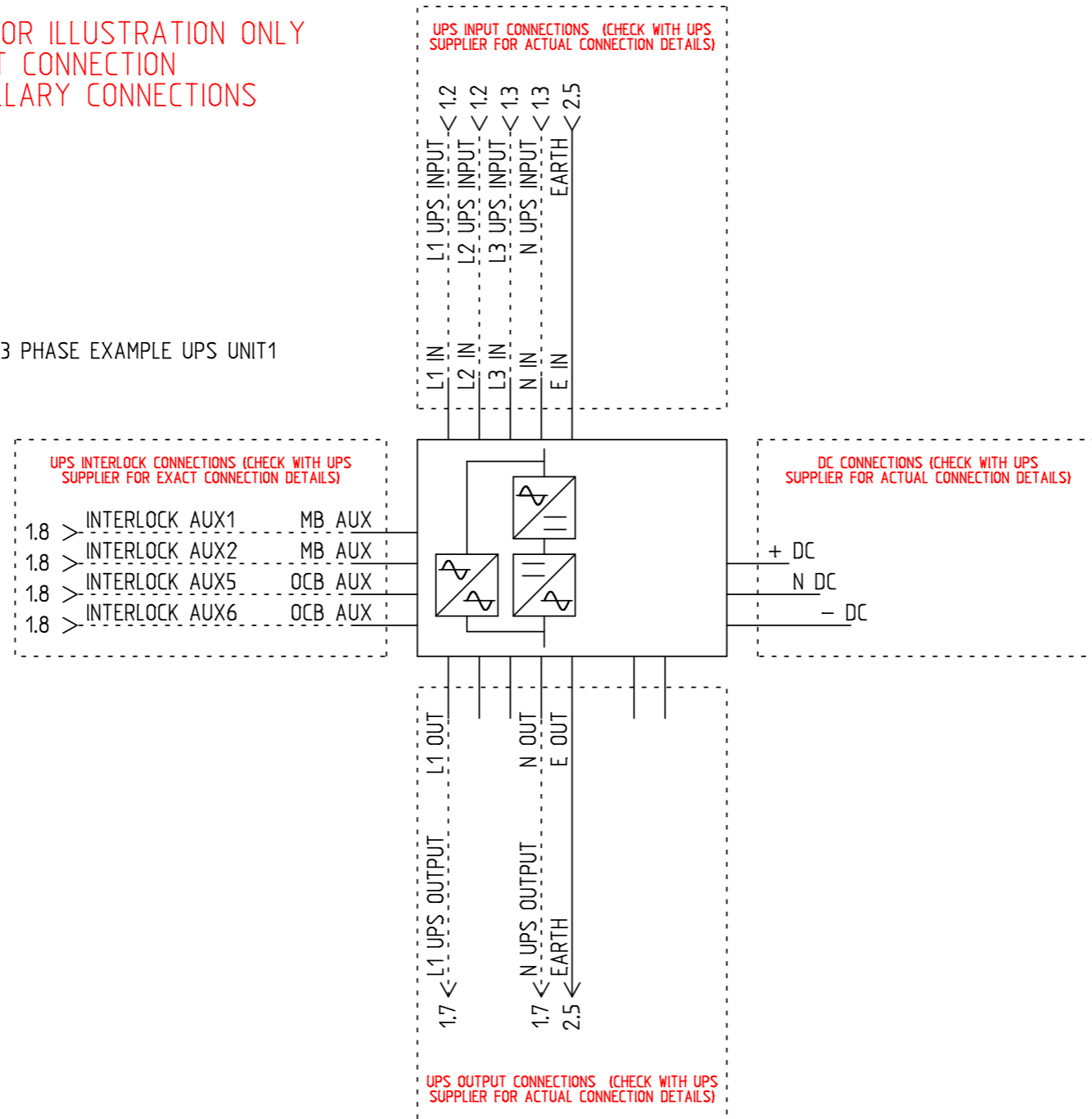

**NOTES:**

- 1) PRODUCT MUST BE INSTALLED IN COMPLIANCE WITH ALL NATIONAL AND LOCAL ELECTRICAL REGULATIONS
- 2) PLEASE REFER TO UPS PRODUCT MANUALS FOR ADDITIONAL INFORMATION
- 3) ALL DIMENSIONS IN MM UNLESS OTHERWISE SPECIFIED
- 4) 4 - CORE SHIELDED SIGNAL CABLE MUST BE RUN FROM EMBS TO EACH UPS UNIT
- 5) ALL DASHED LINES EXTERNAL TO BYPASS PANEL

PRODUCT REF:	RB1-EMBS-400A-31P-ISO-422	REV NO:	1
DOCUMENT NUMBER:	RBECAD00542	CREATION DATE:	25/05/2016
PAGE DESCRIPTION:	UPS UNIT	REV DATE:	24/06/2019
PROJECT NO:	SUBMITTAL DRAWING	DRAWN BY:	R BARNES
PAGE TEMPLATE REF:	RBQS00078REV2	CHECKED BY:	L RICHARDSON
PRODUCT WEIGHT:	65KG	SHEET NUMBER:	2 OF 4

DO NOT USE THIS PROCEDURE IF THE MAINS IS NOT AVAILABLE. IF IN ANY DOUBT CONTACT YOUR UPS SERVICE PROVIDER.

STEP A (NORMAL POSITION)

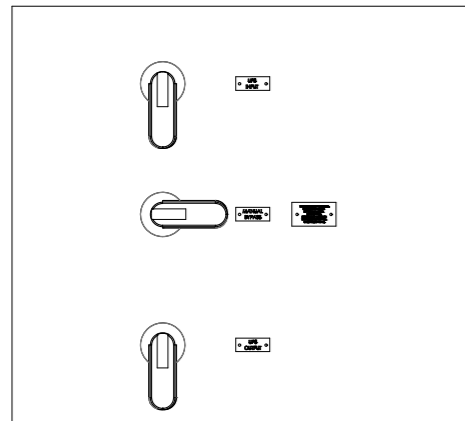

MANUAL BYPASS:  
-IN THE OFF POSITION

UPS OUTPUT:  
-IN THE ON POSITION

UPS UNIT:  
-NORMAL MODE – ONLINE – LOAD ON UPS

STEP B

REFER TO UPS USER MANUAL TO SWITCH THE UPS UNIT (OR UNITS) TO STATIC BYPASS

ONCE UPS UNIT (OR UNITS) ARE IN STATIC BYPASS CONTINUE THE SWITCHING SEQUENCE

MANUAL BYPASS:  
-IN THE OFF POSITION

UPS OUTPUT:  
-IN THE ON POSITION

UPS UNIT:  
-STATIC BYPASS – LOAD ON MAINS

THE UPS MUST BE IN STATIC BYPASS BEFORE CONTINUING OR MAJOR DAMAGE TO THE UPS AND LOSS OF POWER TO THE LOAD WILL OCCUR!

STEP C

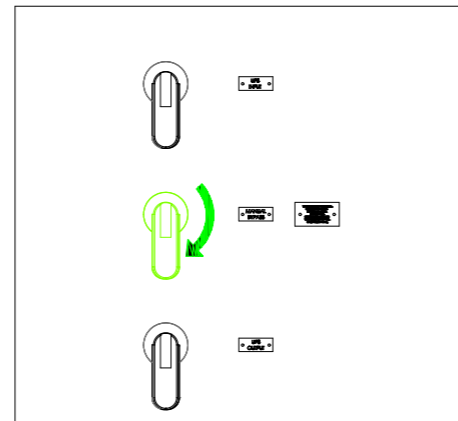

MANUAL BYPASS:  
-IN THE ON POSITION

UPS OUTPUT:  
-IN THE ON POSITION

UPS UNIT:  
-STATIC BYPASS – LOAD ON MAINS

STEP D

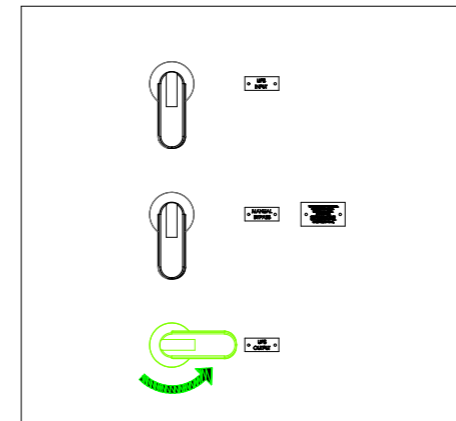

MANUAL BYPASS:  
-IN THE ON POSITION

UPS OUTPUT:  
-IN THE OFF POSITION

UPS UNIT:  
-STATIC BYPASS – LOAD ON MAINS

STEP E (ON BYPASS POSITION)

UPS SYSTEM IS NOW ON EXTERNAL BYPASS

TO RETURN TO NORMAL MODE ONLINE UPS OPERATION FOLLOW THE NEXT SEQUENCE

MANUAL BYPASS:  
-IN THE ON POSITION

UPS OUTPUT:  
-IN THE OFF POSITION

UPS UNIT:  
-STATIC BYPASS – LOAD ON MAINS

STEP F

THIS PROCEDURE ASSUMES:

ALL SWITCH'S ON THE EMBS AND ON THE UPS UNIT SHOULD STILL BE AS PER STEP E ON THE PREVIOUS LINE PRIOR TO PROCEEDING

THE UPS UNIT SHOULD BE IN STATIC BYPASS AND SHOULD BE READY TO ACCEPT THE SYSTEM LOAD

IF IN ANY DOUBT CONTACT YOUR UPS SYSTEM SERVICE PROVIDER BEFORE PROCEEDING

MANUAL BYPASS:  
-IN THE ON POSITION

UPS OUTPUT:  
-IN THE OFF POSITION

UPS UNIT:  
-STATIC BYPASS – LOAD ON MAINS

STEP G

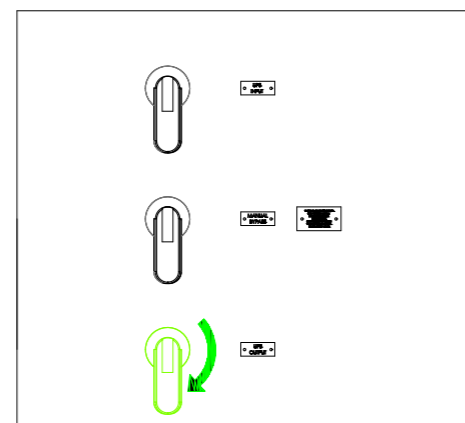

MANUAL BYPASS:  
-IN THE ON POSITION

UPS OUTPUT:  
-IN THE ON POSITION

UPS UNIT:  
-STATIC BYPASS – LOAD ON MAINS

STEP H

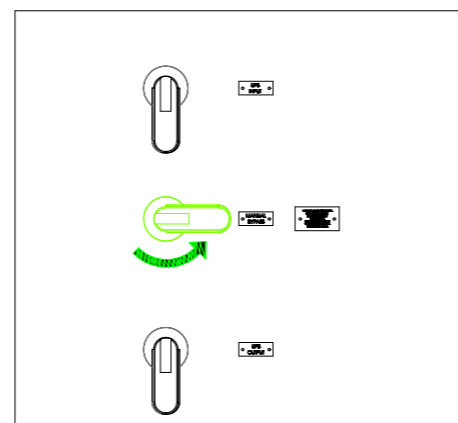

MANUAL BYPASS:  
-IN THE OFF POSITION

UPS OUTPUT:  
-IN THE ON POSITION

UPS UNIT:  
-STATIC BYPASS – LOAD ON MAINS

STEP I

REFER TO UPS USER MANUAL TO SWITCH THE UPS UNIT (OR UNITS) TO ONLINE MODE

ONCE UPS UNIT (OR UNITS) ARE ONLINE THE SEQUENCE IS COMPLETE AND THE LOAD IS NOW BACKED UP BY UPS

IF IN ANY DOUBT CONTACT YOUR UPS SERVICE PROVIDER

MANUAL BYPASS:  
-IN THE OFF POSITION

UPS OUTPUT:  
-IN THE ON POSITION

UPS UNIT:  
-ONLINE – LOAD ON UPS

THE UPS MUST BE IN ONLINE IN NORMAL OPERATION (INVERTER RUNNING) OR LOAD WILL NOT BE PROTECTED.

IF UNSURE CONTACT YOUR UPS SERVICE PROVIDER.

STEP J (NORMAL POSITION)

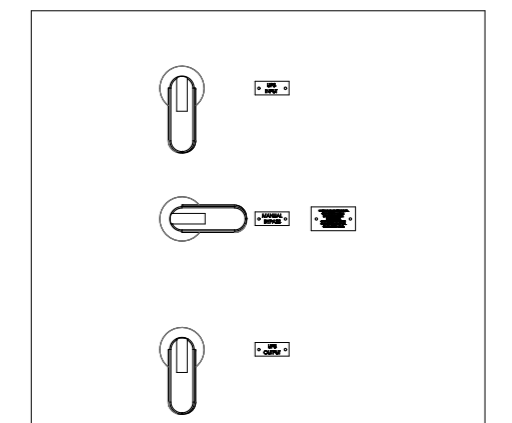

MANUAL BYPASS:  
-IN THE OFF POSITION

UPS OUTPUT:  
-IN THE ON POSITION

UPS UNIT:  
-ONLINE – LOAD ON UPS

NOTES:

- 1) PRODUCT MUST BE INSTALLED IN COMPLIANCE WITH ALL NATIONAL AND LOCAL ELECTRICAL REGULATIONS
- 2) PLEASE REFER TO UPS PRODUCT MANUALS FOR ADDITIONAL INFORMATION
- 3) ALL DIMENSIONS IN MM UNLESS OTHERWISE SPECIFIED
- 4) 4 – CORE SHIELDED SIGNAL CABLE MUST BE RUN FROM EMBS TO EACH UPS UNIT
- 5) ALL DASHED LINES EXTERNAL TO BYPASS PANEL

PRODUCT REF:	RB1-EMBS-400A-31P-ISO-422
DOCUMENT NUMBER:	RBECAD00542
PAGE DESCRIPTION:	INTERLOCK OPERATION
PROJECT NO:	SUBMITTAL DRAWING
PAGE TEMPLATE REF:	RBQS00078REV2
PRODUCT WEIGHT:	65KG

REV NO:	1
CREATION DATE:	29/04/2016
REV DATE:	24/06/2019
DRAWN BY:	R BARNES
CHECKED BY:	L RICHARDSON
SHEET NUMBER:	3 OF 4

# MECHANICAL LAYOUT

TOP VIEW:

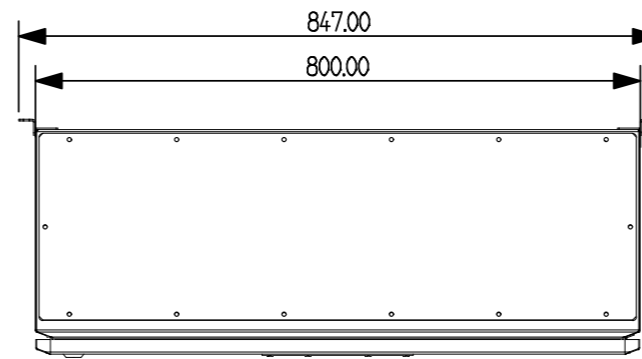

ISO VIEW:

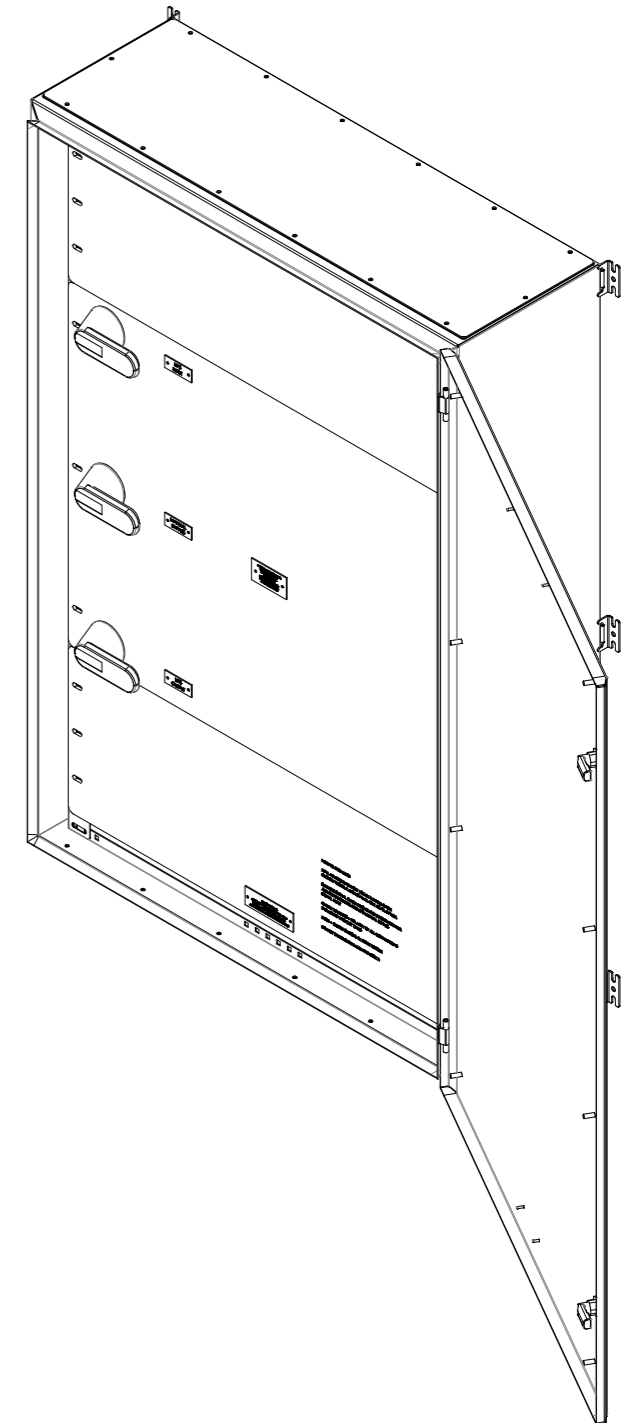

LEFT VIEW:

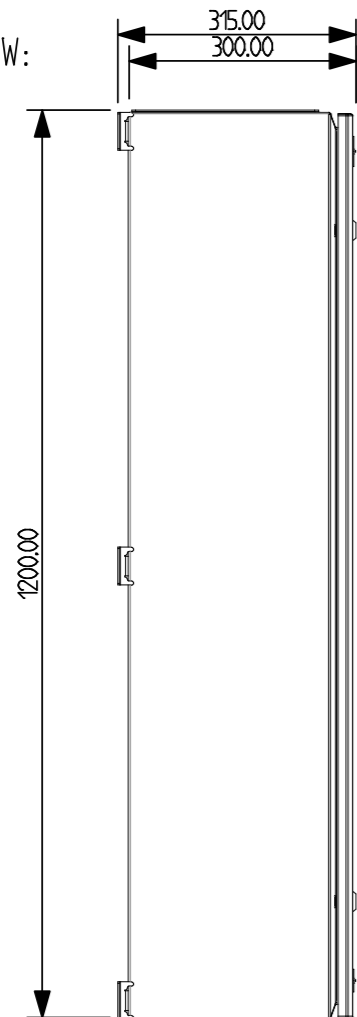

FRONT VIEW:

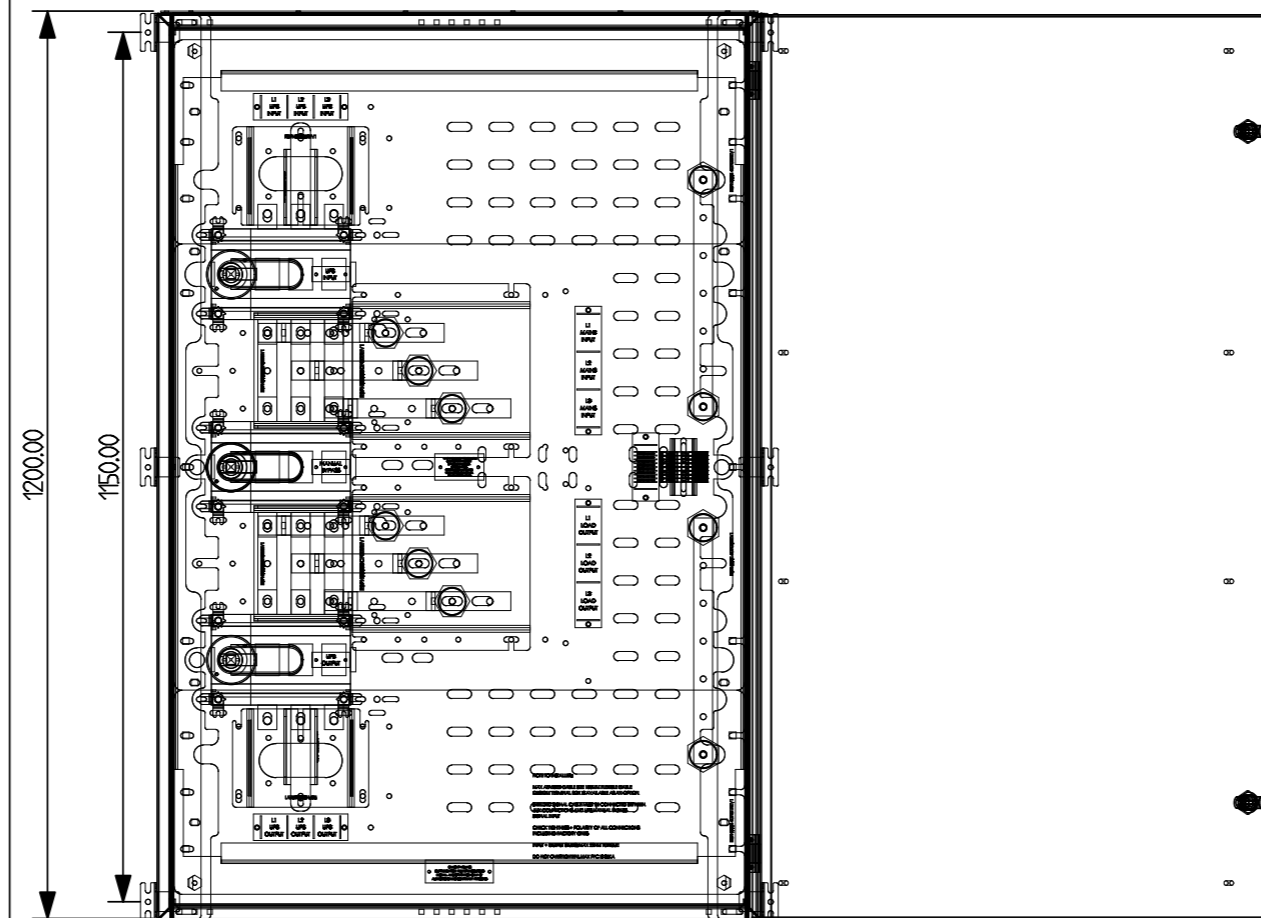

**TERMINATION DETAILS:**

- MAINS INPUT: 8MM BOLT ON BUSBAR (ACCESS TOP/BOTTOM)
- LOAD OUTPUT: 8MM BOLT ON BUSBAR (ACCESS TOP/BOTTOM)
- ALL NEUTRALS: 8MM BOLT ON BUSBAR (ACCESS TOP/BOTTOM)
- ALL EARTH: 8MM BOLT ON BUSBAR (ACCESS TOP/BOTTOM)
- UPS IN: TOP SWITCH 8MM BOLT (ACCESS TOP/BOTTOM)
- UPS OUT: BOTTOM SWITCH 8MM BOLT (ACCESS TOP/BOTTOM)

**NOTES:**

- 1) PRODUCT MUST BE INSTALLED IN COMPLIANCE WITH ALL NATIONAL AND LOCAL ELECTRICAL REGULATIONS
- 2) PLEASE REFER TO UPS PRODUCT MANUALS FOR ADDITIONAL INFORMATION
- 3) ALL DIMENSIONS IN MM UNLESS OTHERWISE SPECIFIED
- 4) 4 - CORE SHIELDED SIGNAL CABLE MUST BE RUN FROM EMBS TO EACH UPS UNIT
- 5) ALL DASHED LINES EXTERNAL TO BYPASS PANEL

PRODUCT REF:	RB1-EMBS-400A-31P-ISO-422	REV NO:	1
DOCUMENT NUMBER:	RBECAD00542	CREATION DATE:	29/04/2016
PAGE DESCRIPTION:	MECHANICAL LAYOUT	REV DATE:	24/06/2019
PROJECT NO:	SUBMITTAL DRAWING	DRAWN BY:	R BARNES
PAGE TEMPLATE REF:	RBQS00078REV2	CHECKED BY:	L RICHARDSON
PRODUCT WEIGHT:	65KG	SHEET NUMBER:	4 OF 4