

AUTOMATIC CHANGEOVER MCCB PAIR. WITH BUILT IN PHASE FAILURE SYSTEM INTERLOCKED TO ONLY ALLOW 1 SUPPLY TO BE ENERGISED AT A TIME

CONTROL UNIT MUST BE SET TO:
 MENU A9: 000 FOR MAINS TO MAINS APPLICATIONS
 MENU A9: 002 FOR MAINS TO GENERATOR APPLICATIONS

24VDC SUPPLY IS ONLY USED IN MAINS TO GEN APPLICATIONS INPUT SUPPLY IS OPTIONAL. IT KEEPS THE CONTROL DISPLAY POWERED BEFORE THE GEN STARTS

GEN START SIGNAL IS ONLY ENABLED WHEN ATS MODULE IS SET TO MAINS - GEN OPERATING MODE
 MENU A9 - SET TO 002

- NOTES:**
- 1) PRODUCT MUST BE INSTALLED IN COMPLIANCE WITH ALL NATIONAL AND LOCAL ELECTRICAL REGULATIONS
 - 2) PLEASE REFER TO UPS PRODUCT MANUALS FOR ADDITIONAL INFORMATION
 - 3) ALL DIMENSIONS IN MM UNLESS OTHERWISE SPECIFIED
 - 4) 4 - CORE SHIELDED SIGNAL CABLE MUST BE RUN FROM EMBS TO EACH UPS UNIT
 - 5) ALL DASHED LINES EXTERNAL TO BYPASS PANEL

PRODUCT REF:	RB1-ATS-100A-2P-MCCB	REV NO:	1
DOCUMENT NUMBER:	RBECAD-00394	CREATION DATE:	19/08/2016
PAGE DESCRIPTION:	AUTO CHANGEOVER SECTION	REV DATE:	24/08/2018
PROJECT NO:	SUBMITTAL DRAWING	DRAWN BY:	R BARNES
PAGE TEMPLATE REF:	RBQS00075REV2	CHECKED BY:	L RICHARDSON
PRODUCT WEIGHT:	25KG	SHEET NUMBER:	1 OF 2

ENCLOSURE LAYOUT

LEFT VIEW

FRONT/REAR VIEW

RIGHT VIEW

ISOMETRIC VIEW

TOP VIEW

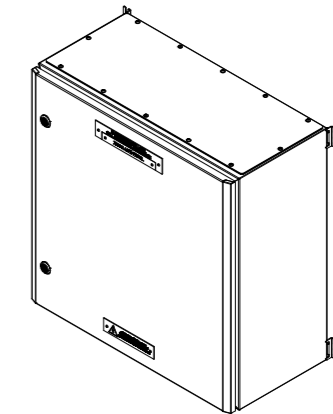
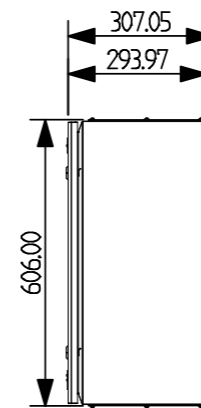
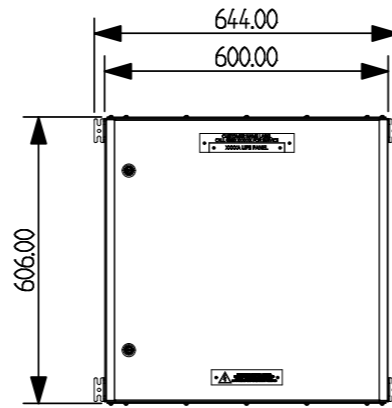
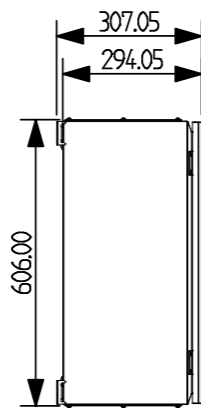
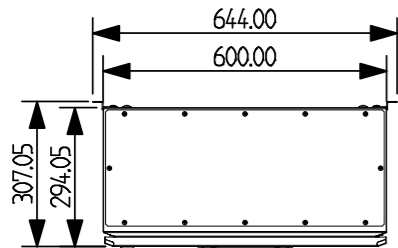

BOTTOM VIEW

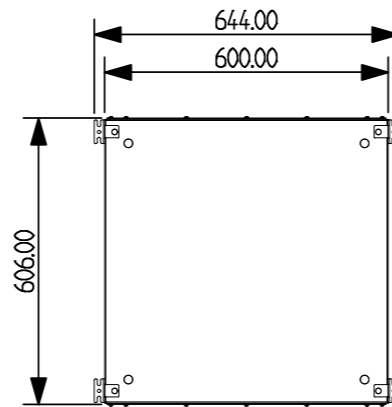
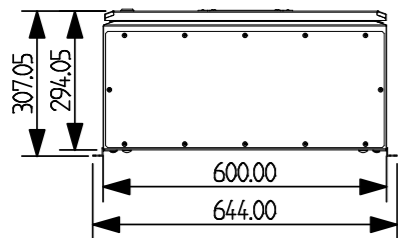

NOTES ON MECHANICAL LAYOUT:

1. ENCLOSURE CAN BE INSTALLED WITHOUT MOUNTING FEET IF PREFERRED
2. DOOR CAN BE HUNG ON OPPOSITE SIDE ON REQUEST

NOTES:

- 1) PRODUCT MUST BE INSTALLED IN COMPLIANCE WITH ALL NATIONAL AND LOCAL ELECTRICAL REGULATIONS
- 2) PLEASE REFER TO UPS PRODUCT MANUALS FOR ADDITIONAL INFORMATION
- 3) ALL DIMENSIONS IN MM UNLESS OTHERWISE SPECIFIED
- 4) 4 - CORE SHIELDED SIGNAL CABLE MUST BE RUN FROM EMBS TO EACH UPS UNIT
- 5) ALL DASHED LINES EXTERNAL TO BYPASS PANEL

PRODUCT REF:

RB1-ATS-100A-2P-MCCB

DOCUMENT NUMBER:

RBECAD-00394

PAGE DESCRIPTION:

MECHANICAL LAYOUT

PROJECT NO:

SUBMITTAL DRAWING

PAGE TEMPLATE REF:

RBQS00078REV2

PRODUCT WEIGHT:

25KG

REV NO:

1

CREATION DATE:

29/04/2016

REV DATE:

15/04/2026

DRAWN BY:

R BARNES

CHECKED BY:

L RICHARDSON

SHEET NUMBER:

2 OF 2